

P&M[®] **TD960** Heavy Duty Floor Spring

- *Double Action Floor Spring*
- *Interchangeable Spindle*
- *Adjustable Spring Power from EN3 to EN6*
- *Suitable for door weight up to 300kg*

Applications

- Heavy duty floor spring which is capable of holding door panel weight up to 300 kg.
- Suitable for single and double action doors.
- Interchangeable spindles for easy adaptation to site conditions
- TD960 Non-Hold is available for fire rated door application.
- Comprehensive range of accessories for aluminium, tempered glass and timber door.

Closing Range and Functions

- 1st adjusting closing range (180°-15°).
- 2nd adjusting latching range (15°-0°).
- Hold open at 90°.
- Optional non-hold to realise full benefits of fully hydraulic closing speed control effective from 180° to 15°.
- Adjustable Spring Power: EN3 to EN6.
- Pressure relief valves to prevent damages due to force closing.
- Mechanical backcheck 70° - 75° to cushion against impact.

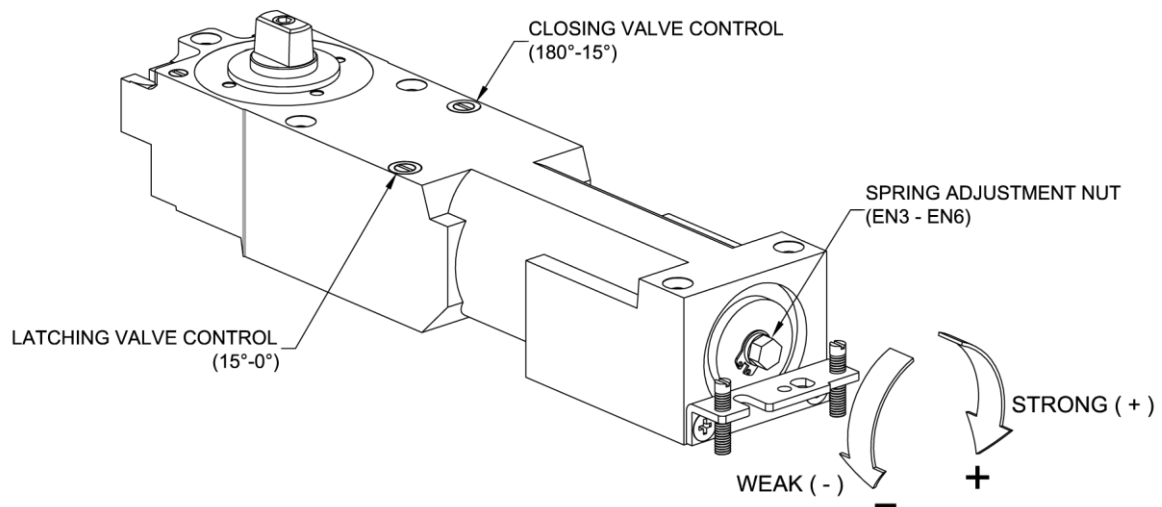
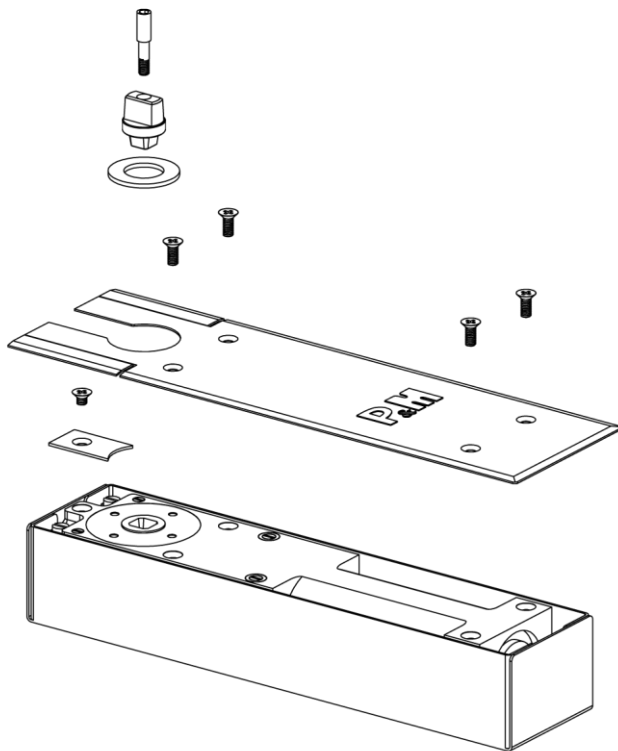

SPRING POWER	DOOR SIZE	SPRING FORCE
EN6	1400 mm	53 N
EN5	1250 mm	35 N
EN4	1100 mm	28 N
EN3	1000 mm	23 N

Dimensions

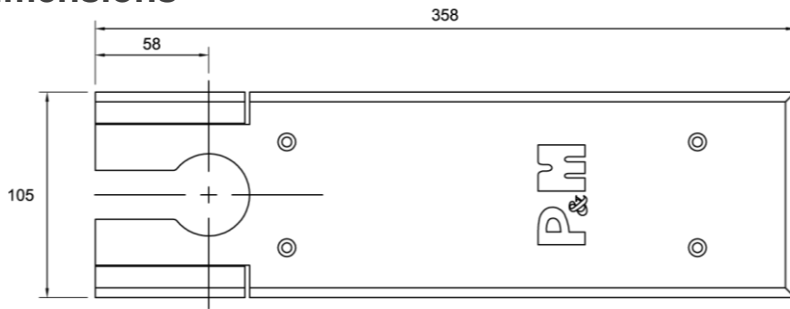

Stainless Steel Cover

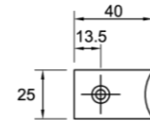



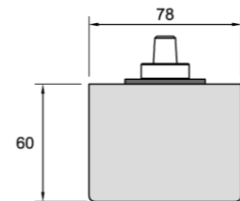
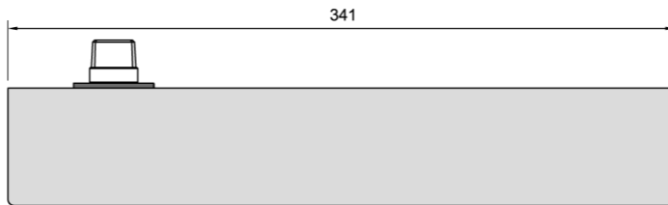
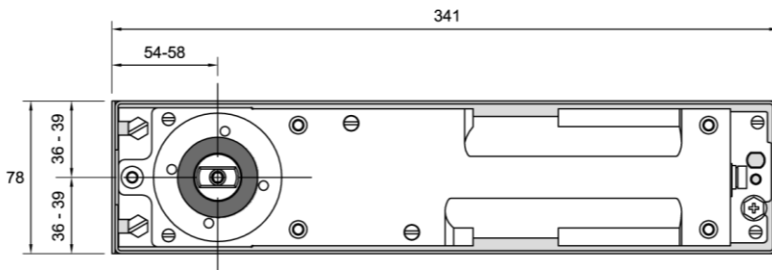



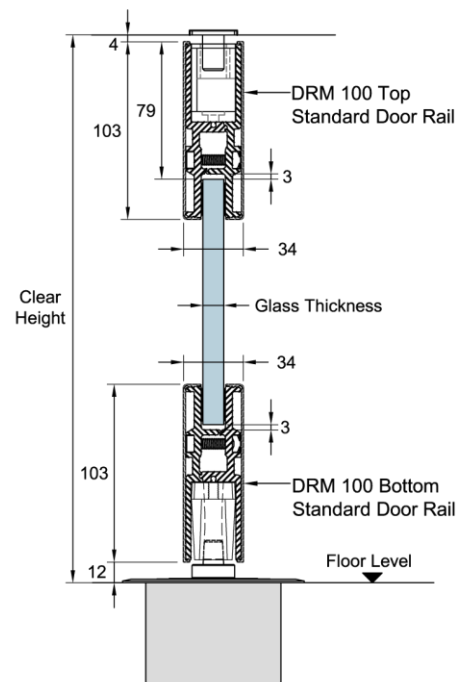
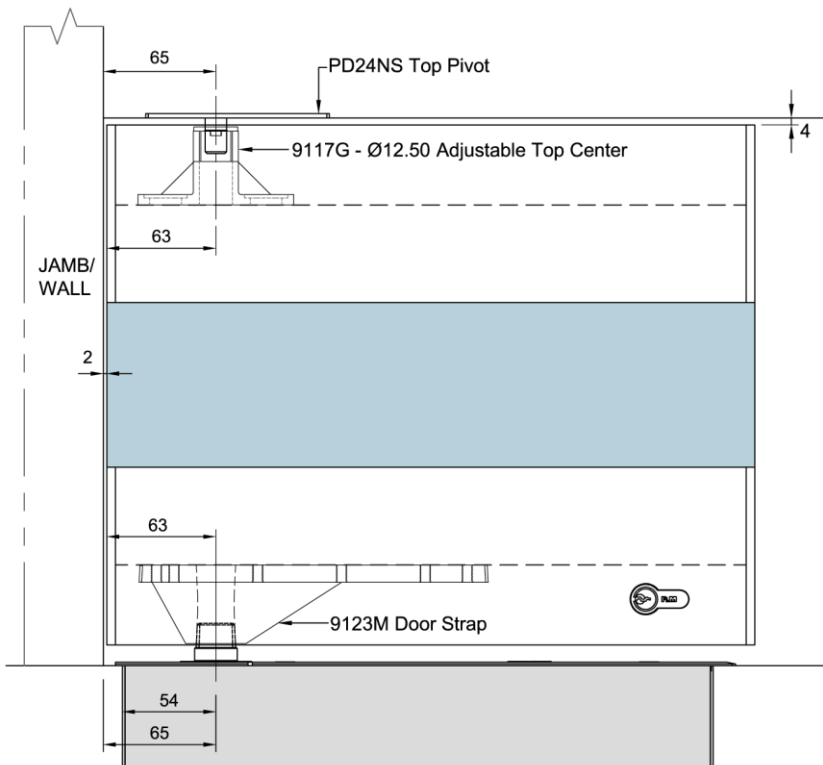







Stainless Steel End Cover



Glass Door Application



INTERCHANGEABLE SPINDLE

Extended Spindle Height in mm (H)	3	8	10.5	13	15.5	18	23	28	31	33	38	43	48	53
Extra Over Height in mm (Y)	0	5	7.5	10	12.5	15	20	25	28	30	35	40	45	50
														

* 8mm Extended Spindle Height (H)
(+5 Spindle)

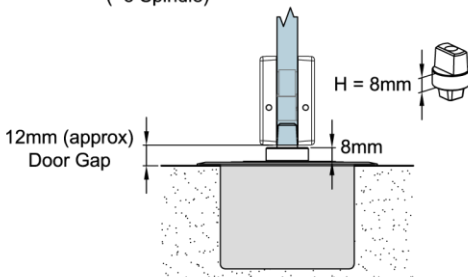

* Standard packing includes 8mm extended spindle height interchangeable spindle.

H = Extended Spindle Height

Y = Extra Over Height
Y = H - 3mm

X = Door Gap
X = Y + 7mm (approx)

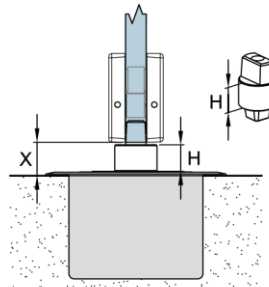

Extended Spindle Height Illustration

Technical Data

TD 960

Spring Power (EN)	3 to 6	
Spring Power Adjustment	•	
Interchangeable Spindle	•	
Built-in pressure relief valve	•	
Built-in mechanical backcheck 70° - 75°	•	
90° Hold open / Non-hold open	•	
Maximum weight (kg)	300	
Dimension in mm	Length	341
	Width	78
	Height	60
Product weight (kg) (approx.)	7.7	

• Yes

Door Control

Two independent adjustment valves provide fully hydraulic control from 180° - 15° of closing and hydraulic control 15°-0° of latching range.

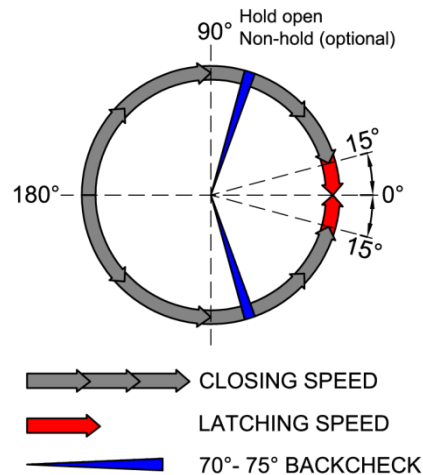

Due to the company's policy of continuous product development and enhancement, the specifications and details contained in this brochure are subject to alteration without prior notice.

The dimensions, details, specifications and statements made herein or by our representatives arising out of any enquiries are given for information purposes only. They are not intended to have any legal effect and the company will not be bound thereby. The company will only accept obligations which are expressly negotiated for, and agreed and incorporated into written agreements made specifically with its respective customers.