

P & M[®] TD960S

Heavy Duty Floor Spring

- *Double action floor spring*
- *Door weight up to 300kg*
- *Door width up to 1800mm*
- *Positive centering*

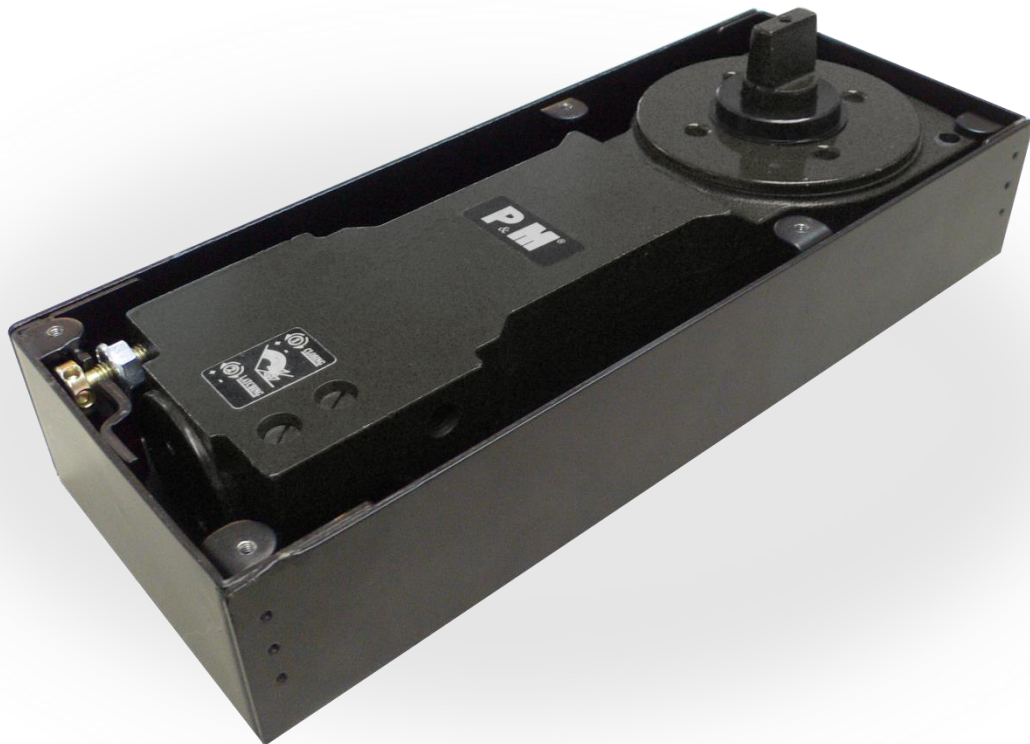

Applications

- Heavy duty floor spring which is capable of holding door panel weight up to 300 kg and door width up to 1800mm
- Suitable for single and double action doors.
- TD960S Non-Hold is available for fire rated door application.
- Comprehensive range of accessories for aluminium, tempered glass and timber door.

Closing Range and Functions

- 1st adjusting closing range (116°-15°).
- 2nd adjusting latching range (15°-0°)
- Hold open at 90°.
- Optional non-hold to realise full benefits of fully hydraulic closing speed control effective from 116° to 15°.
- Maximum Spring Power: 53N-56N.
- Pressure relief valves to prevent damages due to force closing.
- Mechanical backcheck 70° - 75° to cushion against impact.
- Double locating cam resulting in positive centering.

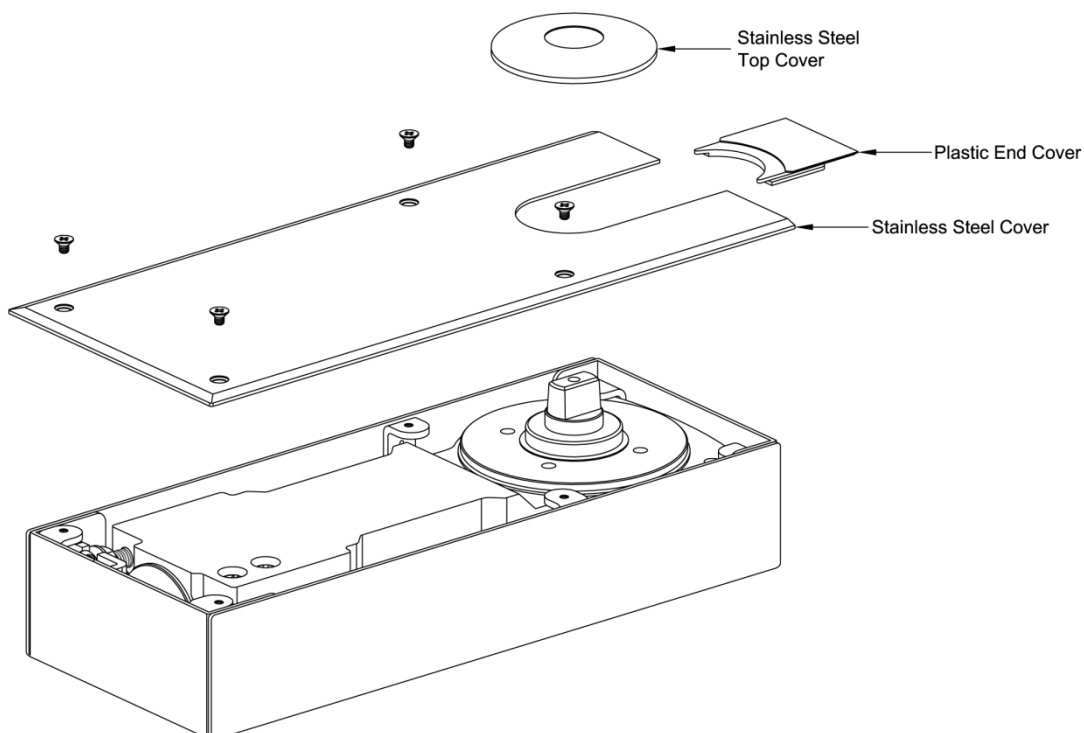
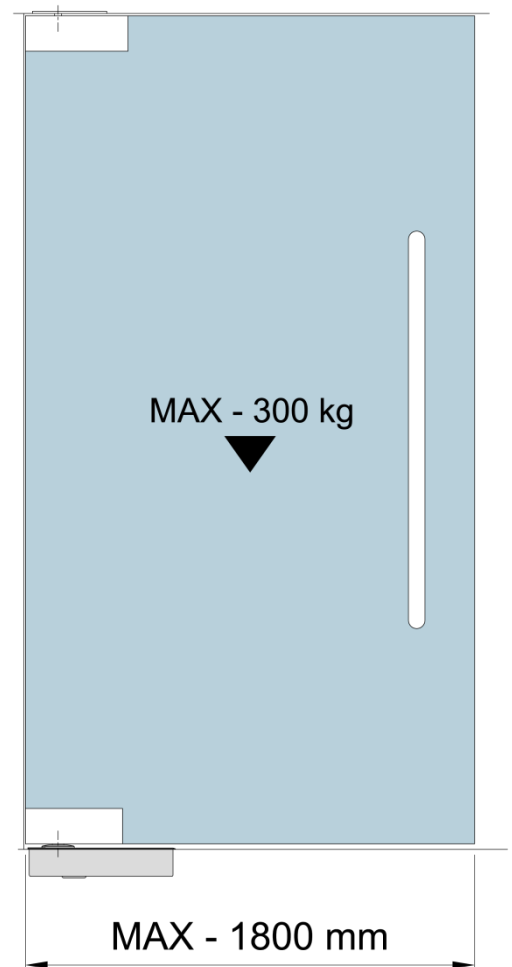

Dimensions

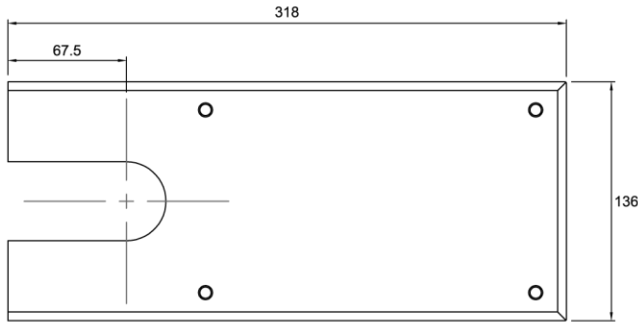

Stainless Steel Cover

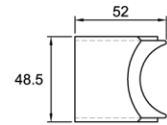

Plastic End Cover

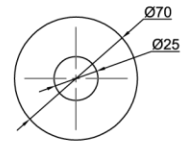

Stainless Steel Top Cover

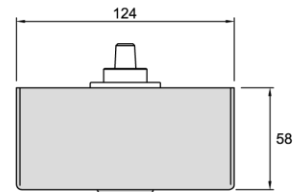
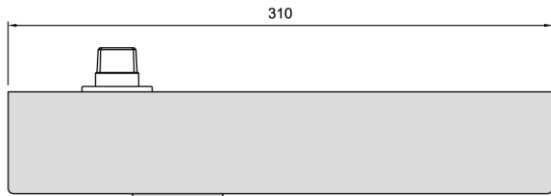
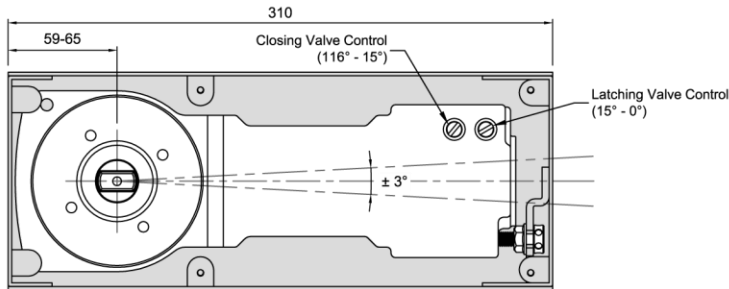

Glass Door Application

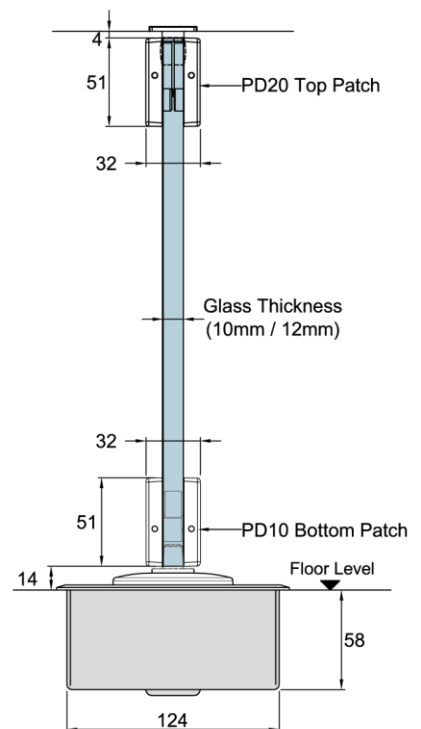
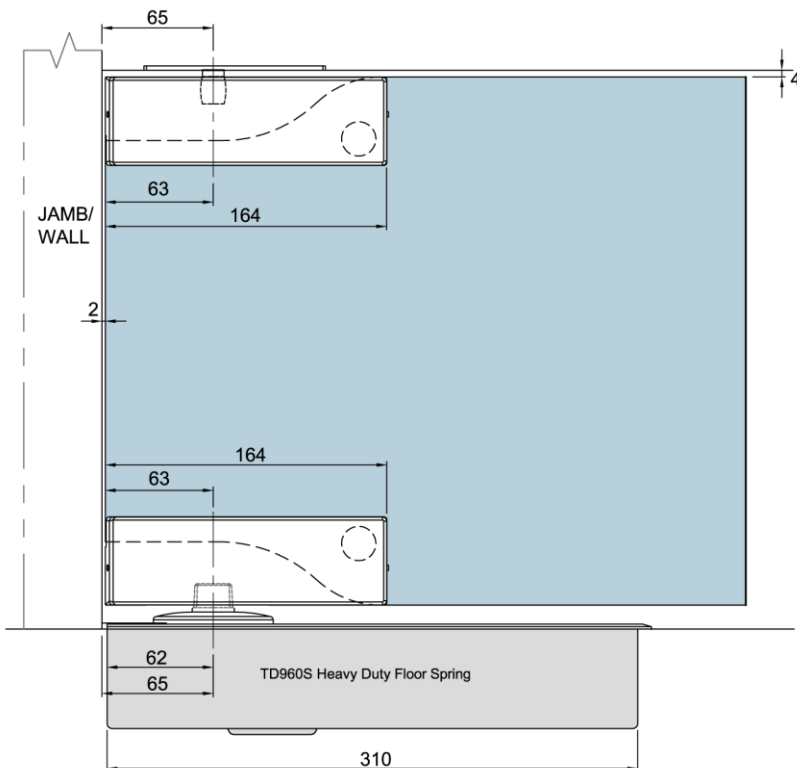

Technical Data		TD 960S
Spring Power		53N - 56N
Built-in pressure relief valve		•
Built-in mechanical backcheck 70° - 75°		•
90° Hold open		•
Maximum weight (kg)		300
Dimension in mm	Length	310
	Width	124
	Height	58
Product weight (kg) (approx.)		7.5

• Yes

Door Control

Two independent adjustment valves provide fully hydraulic control from 116° - 15° of closing and hydraulic control 15°-0° of latching range.

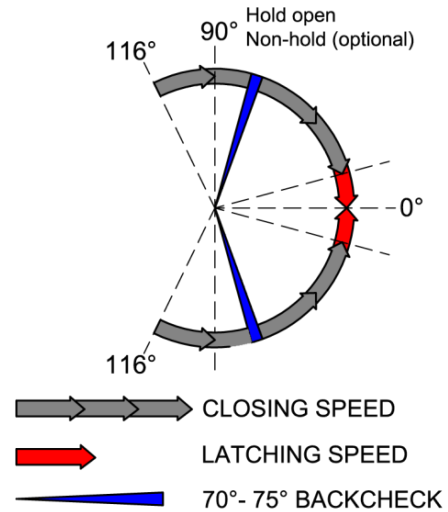

Accessories for Aluminium Framed and Wooden Doors

9116
Retractable Top Pivot
c/w stainless steel plate

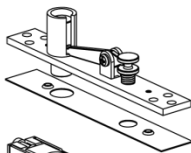

9117
Adjustable Top Centre

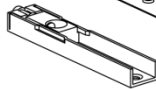

9123L
Door Strap

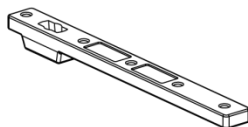

9119 Offset
(Left Hand or Right Hand)

Top Pivot Offset (LH)

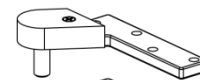

Top Centre Offset (LH)

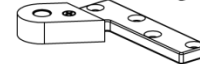

Bottom Strap (LH)

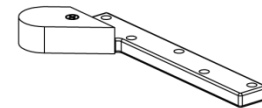

Due to the company's policy of continuous product development and enhancement, the specifications and details contained in this brochure are subject to alteration without prior notice.

The dimensions, details, specifications and statements made herein or by our representatives arising out of any enquiries are given for information purposes only. They are not intended to have any legal effect and the company will not be bound thereby. The company will only accept obligations which are expressly negotiated for, and agreed and incorporated into written agreements made specifically with its respective customers.